

Panasonic

Portable CD-ROM Player

Operating Instructions

Model No. **KXL-810A**

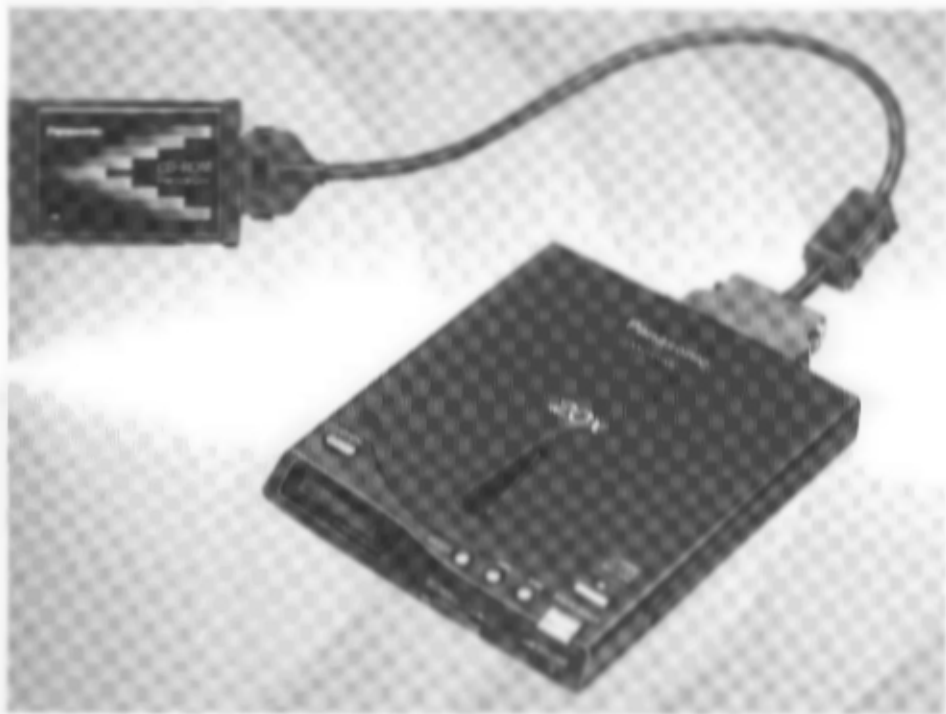

This manual contains the information on handling the player. Please read this manual first. For the information on setting up the driver for use with your computer, please read the Setup Manual enclosed with this manual.

Please read this manual and the enclosed Setup Manual completely before use. Keep these documents in a safe place for future reference.

Thank you for purchasing the Panasonic Portable CD-ROM Player KXL-810A.

WARNING

- The power source voltage of the AC adaptor is listed on the nameplate. Plug the AC adaptor only into an outlet with the proper voltage.
- To prevent fire or shock hazard, do not expose this product to rain or any type of moisture.

CAUTION

- When you operate this equipment, the mains socket-outlet should be near the equipment and should be easily accessible.
- To prevent the SCSI interface connector from static electricity damage, before you touch it, discharge any static electricity from your hands by touching a grounded metal surface, such as the screw on the plate cover of an electrical outlet.

CAUTION FOR LASER

This product utilizes a laser.

Use of control, adjustment or performance of procedures other than those specified herein may result in hazardous radiation exposure.

Do not open covers and do not repair yourself. Refer servicing to qualified personnel.

Laser diode properties

Material	AlGaAs
Laser output	Less than 48.5 μ W
Wave length	785 nm
Emission duration	Continuous

(This output is the value measured at the distance of 200 mm from the objective lens surface.)

The serial number of this unit may be found on the label located at the bottom of the unit. Write this number below and keep this book along with your proof of purchase to serve as a permanent record of your purchase or for future reference.

For warranty service you may be required to show your proof of purchase records.

MODEL NO. **KXL-810A** _____ NAME OF DEALER _____

SERIAL NO. _____ DATE OF PURCHASE _____

FOR USERS IN UNITED STATES ONLY

This equipment has been tested and found to comply with the limits for a Class B digital device, pursuant to Part 15 of FCC Rules. These limits are designed to provide reasonable protection against harmful interference in a residential installation.

This equipment generates, uses and can radiate radio frequency energy and, if not installed and used in accordance with the instructions, may cause harmful interference to radio communications.

However, there is no guarantee that interference will not occur in a particular installation. If this equipment does cause harmful interference to radio or television reception, which can be determined by turning the equipment off and on, the user is encouraged to try to correct the interference by one or more of the following measures:

- Reorient or relocate the receiving antenna.
- Increase the separation between the equipment and receiver.
- Connect the equipment into an outlet on a circuit different from that to which the receiver is connected.
- Consult the dealer or an experienced radio/TV technician for help.

The user may find the booklet "Something About Interference" available from FCC local regional offices helpful.

FCC Warning: To assure continued FCC emission limit compliance, the user must use only the recommended shield interfacing cable when connecting to a host computer. Also, any unauthorized changes or modifications to this equipment would void the user's authority to operate this device.

- Microsoft, MS-DOS, Windows and Windows NT are registered trademarks of Microsoft Corporation in the United States and/or other countries.
- Photo CD is a registered trademark of Eastman Kodak Company.
- Adaptec is a registered trademark of Adaptec, Inc.
- Zip and Jaz are trademarks of Iomega Corporation.

All other brands and product names are trademarks or registered trademarks of their respective companies.

It is granted from Microsoft Corporation to use Microsoft® Windows® Screen Shots.

Specifications given in these Operating Instructions are subject to change without notice.

© KYUSHU MATSUSHITA ELECTRIC CO., LTD. 1997

■ Features:

- **20X Speed external CD-ROM player** (transfer rate Max. 3000 KB/s when connected to a desktop computer using a commercial SCSI board or Max. 2700 KB/s when connected to a notebook/desktop computer using the supplied interface card).^{*1}
- **Operates on universal voltage AC adaptor** (☞ P. 13), **rechargeable battery (option)** (☞ P. 27), **six (6) "AA" size alkaline batteries (not supplied) or power from a computer (via PCMCIA Type II card slot ^{*2})** (☞ P. 29).
- **Can be connected to a notebook/desktop computer which has PCMCIA card slot with supplied interface card and cable** (☞ P. 14).
- **Can be connected to a desktop computer with purchase of SCSI board and SCSI cable** (☞ P. 16).
- **Can be connected to a Zip or Jaz drives when used with a notebook/desktop computer which has PCMCIA card slot with purchase of SCSI cable and SCSI changer adaptor** (☞ P. 15).
- **Both CD-ROM and audio CD can be played when attached to your computer** (☞ P. 20).
- **Can be used independently as an audio CD player** (☞ P. 18).
- **Supports CD-ROM, CD-ROM XA, CD-DA, Photo CD (Multisession), CD-i ^{*3}, VIDEO CD ^{*3}, CD Extra.**

^{*1} Performance will vary based on computer specifications. All performance specifications are based on use with AC adaptor.

^{*2} PCMCIA Type II card slot is referred to as a PCMCIA card slot in this manual.

^{*3} To playback CD-i or VIDEO CD, software or hardware MPEG decoding capability is required in the computer.

Important:







- Please use CD-ROMs with the marking below.

COMPACT
disc

- Please use audio CDs with the marking below.

COMPACT
disc
DIGITAL AUDIO

Table of Contents

Before Use	Accessories 6 Precautions 7 Part Names 10	
Preparation & Connection	Connecting the AC Adaptor 13 Preparation 14 For notebook / desktop computer with PCMCIA card slot (interface card) 14 For desktop computer with SCSI board 16 Inserting / Removing a CD 17	
Operation	Using the Player Independently 18 Playing an audio CD 18 Using the Player with Computer 20 Playing a CD-ROM 21 Playing an audio CD 21 Insertion / Removal of the interface card 24	
Using Other Powers	Using Alkaline Batteries (not supplied) 25 Using Rechargeable Battery (option) 27 Installing / Removing rechargeable battery 27 Charging rechargeable battery 28 Using the Power from a Computer (through the Interface Card) 29	
Troubleshooting & Maintenance	Troubleshooting 31 Maintenance 35	
Technical Information	SCSI ID Number and Terminator Setting 36 Specifications 37	
Appendix	Option / Recommended Products 39 End-User License Agreement 40 Index 42	

Accessories

Make sure that the following accessories are included with the player. If anything is missing, contact your dealer immediately.

AC adaptor

(☞ P. 13)

(The Model No. of AC adaptor is written on the bottom of the player.)

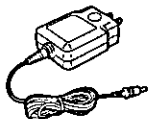

Battery case

(☞ P. 25)

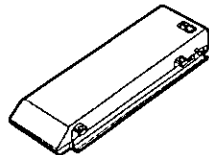

Setup disk

(☞ P. 14)

[Before opening the packet, please read P. 40.]

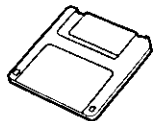

Operating Instructions

(this manual)

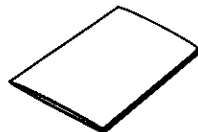

Interface card

(PCMCIA Type II)

(☞ P. 14)



Setup Manual

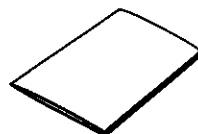

Interface cable

(☞ P. 14)

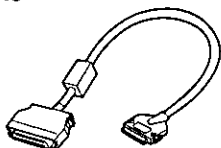

Warranty card

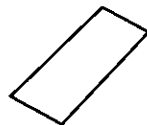

Precautions

General

- Do not disassemble the player and do not repair yourself, or it may cause electrical shock hazard, or a laser may damage your eyes.

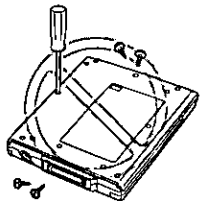

- Do not use the headphones or do not operate the switches/buttons while riding a vehicle.

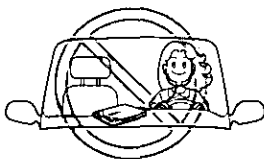

- Do not store or use the player in a dusty, humid, oily environment, or under damp or moist conditions.

- When the player has been moved from a cold place to warm place, it may damp or moist. Leave the player for about 1 hour before using.

- Do not turn up the volume too high, when using the headphones.

- Keep magnetic objects away from the player.

- Do not leave the player in direct sunlight, near a heat source or especially in a hot automobile.

- Do not insert any foreign metal object inside the player.

- Do not drop or jar the player.

- Do not touch the lens.

- Do not touch the pins/terminals of the interface card and cable.

- If noise is heard from radio or TV, move the player 2 m (about 6 ft.) away from the radio or TV.



AC Adaptor

- Do not plug-in or remove the AC adaptor using wet hands.

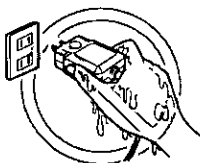

- Do not damage the AC adaptor by scratching or modifying, or bending its prongs.

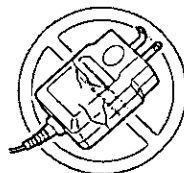

- Make sure the AC outlet or cord for the AC adaptor does not exceed the limit of their electrical ratings.

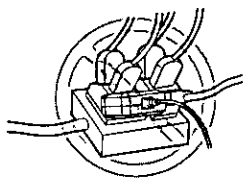

- Do not use the AC adaptor under the following conditions.
 - when it is damaged
 - when there is smoke or strange smell
 - when an abnormal sound is heard

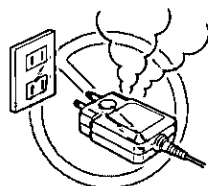

- Make sure the prongs of AC adaptor are fully inserted into the AC outlet.

- Use only the supplied AC adaptor (P. 6).

- Periodically remove the dust from the prongs of AC adaptor.

- Do not disassemble the AC adaptor.

- Only use the AC adaptor indoors.



Alkaline Batteries

To avoid the leakage or corrosion, observe the followings. If leakage or corrosion occurs, replace the batteries immediately with fresh ones.

- Do not charge, short-circuit, disassemble, heat, or dispose of batteries in fire.



- Use only "AA" size alkaline batteries.

- Do not install used batteries with new batteries. Do not mix any other kind of batteries with alkaline batteries.

- Remove the batteries as soon as they are used up.

- Make sure the polarity (+, -) matches the diagram inside the battery case.

Rechargeable Battery

- Use only the optional rechargeable (Ni-Cd) battery (KXL-D32).
- The nickel cadmium battery you have purchased is recyclable. At the end of its useful life, under various state and local laws, it is illegal to dispose of this battery into your municipal waste stream. Please call 1-800-8-BATTERY for information on how to recycle this battery.

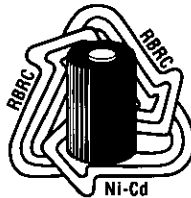

Valid in USA only

CD

- Do not scratch, smudge, write or label both surfaces of CD.
- Do not leave the CD in direct sunlight, near a heat source or especially in a hot automobile.
- Do not throw or bend CD.
- Do not touch the signal side (the side without the label) of CD. Avoid finger prints and scratch while holding it.

Part Names

■ Front / Left Side view

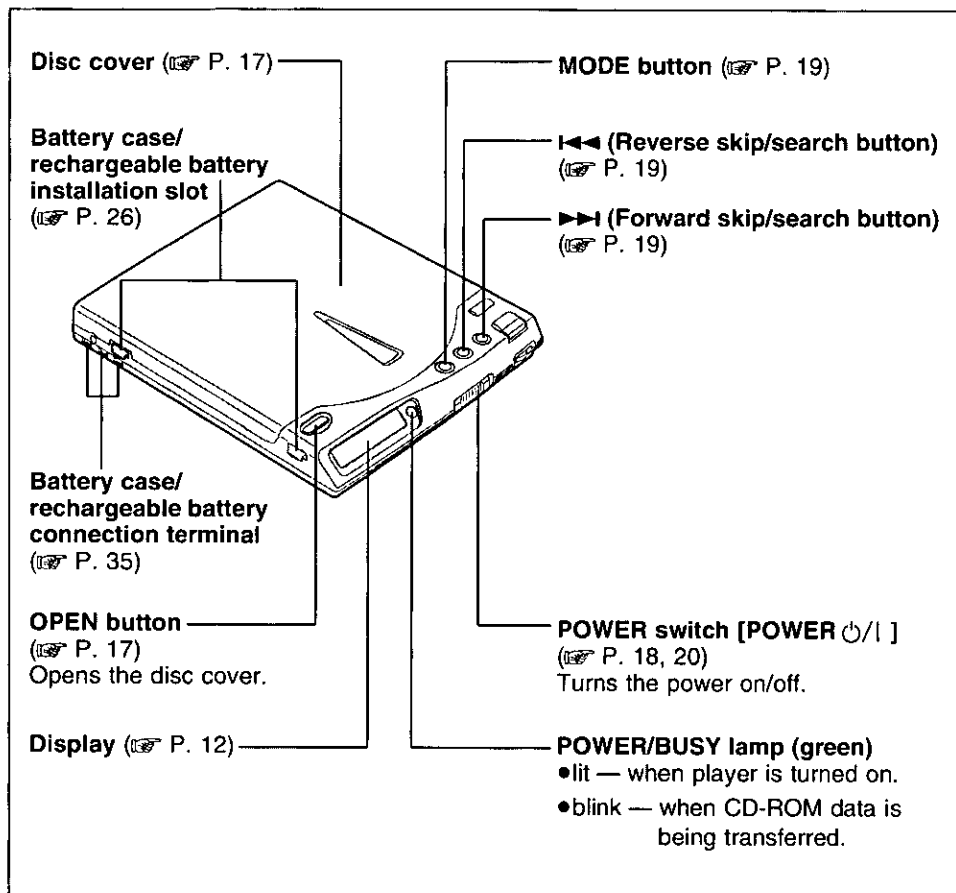

Note:

- For the battery case, please refer to the page 25 and 26.

■ Front (right corner) / Right Side view

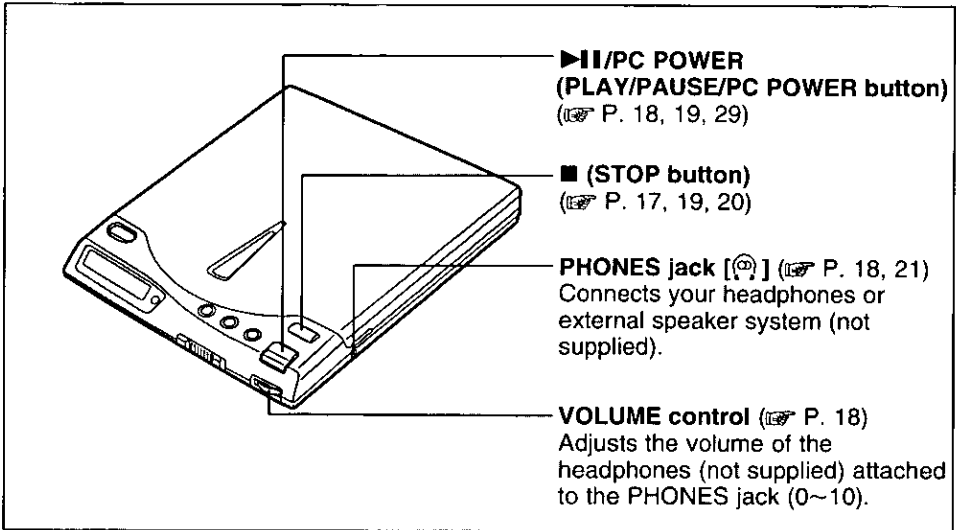



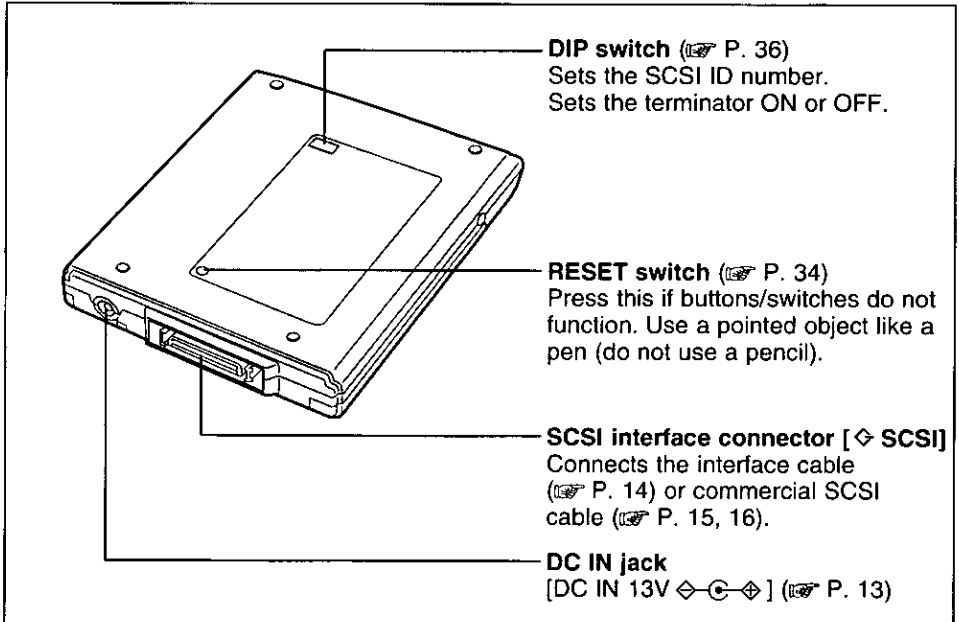





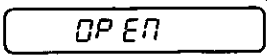

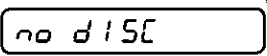
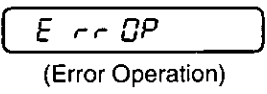







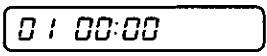

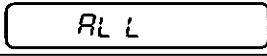

■ Rear / Bottom view

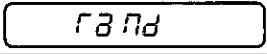

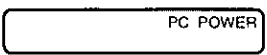
Part Names

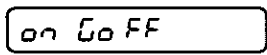
■ Display messages

Message/Indication	Description
	The disc cover is open.
	<ul style="list-style-type: none"> •When CD-ROM is inserted, a message "on" is displayed. •While CD-ROM or audio CD is first being recognized, "on" blinks.
	CD is not inserted, or the inserted CD is not recognized because either the CD is placed with the label side facing down, or it is damaged, dirty, wet, etc.
 (Error Operation)	<ul style="list-style-type: none"> •When using the player connected with the supplied interface card, you pressed  or . •When using the player connected to a SCSI board, you pressed ,  or . •When using the player independently with a CD-ROM inserted in the player, you pressed ,  or .
	<ul style="list-style-type: none"> •Displayed when an audio CD is recognized. • is pressed when an audio CD is being played on the player.
	Pressing  changes the audio CD playback mode. The modes are outlined below.
	
	
	This blinking indication appears when the battery or rechargeable battery is low while being powered from it.
	The player is being powered from the computer. ("on" will blink until the player and computer preparations are complete.)
	 blinks when the battery of the computer is low or the power supply capacity from the computer is not sufficient while being powered from the computer.
	With a CD-ROM inserted in the player, if you press  , this message appears. (P. 33)

* "PC POWER" is displayed at the upper right hand corner of the display when the player is being powered from the computer.

Connecting the AC Adaptor

Connect the supplied AC adaptor.

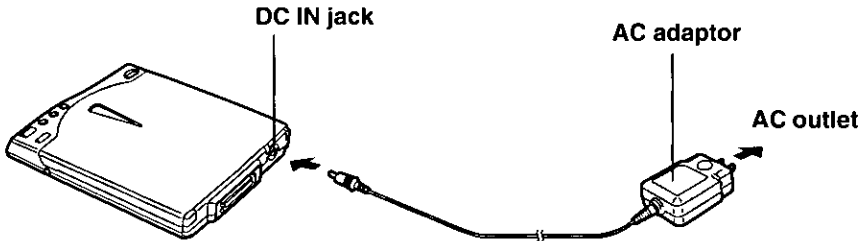

Caution:

- Use only the supplied AC adaptor, since other adaptors could damage the player.

Notes:

- If the player is not going to be used for an extended period, unplug the AC adaptor from the AC outlet to save power consumption. (Approximately 1 W of power is consumed when the player is OFF and the AC adaptor is connected with 120 V outlet.)
- The AC adaptor is universal voltage. However, it is designed for use only in the country where it was purchased.



Preparation

For notebook / desktop computer with PCMCIA card slot (interface card)

Step 1 Connection

To use the supplied interface card, connect to the supplied interface cable. For connection with the computer, refer to the enclosed Setup Manual.

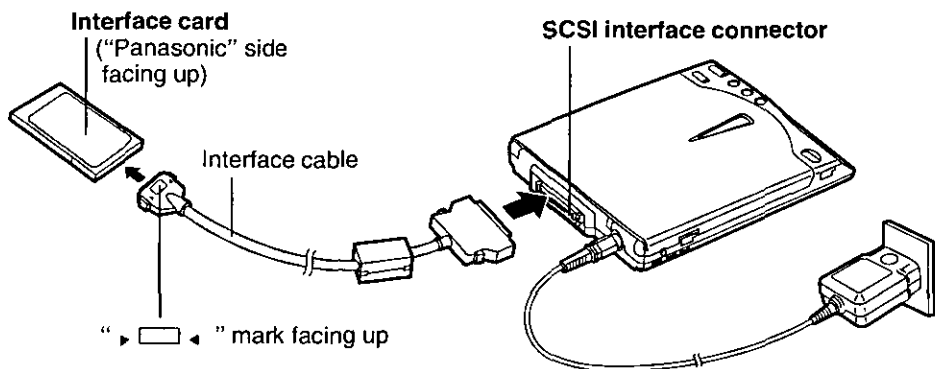

■ Disconnecting interface card from interface cable:

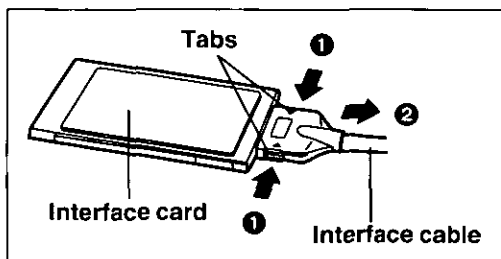

While pressing the side tabs of it (①), pull the interface cable straight (②).

Caution:

- Do not force the interface cable since this could damage the interface card or cable.

Step 2 Setting up your computer

To use the player with a computer, you must set up your computer using the supplied Setup disk.

Please refer to the enclosed Setup Manual.

■ Connection with Zip or Jaz (for Windows® 95 * only):

You can connect the Zip or Jaz and your computer with PCMCIA card slot using the supplied interface card and cable. The interface cable supplied with the player has a different connector than required by your Zip. The SCSI changer adaptor will allow the interface cable to connect to your Zip. If necessary you can connect the player and Zip or Jaz using a commercial SCSI cable. For further information, refer to your Zip or Jaz manual.

Example connecting with Zip or Jaz (the player is also connected)

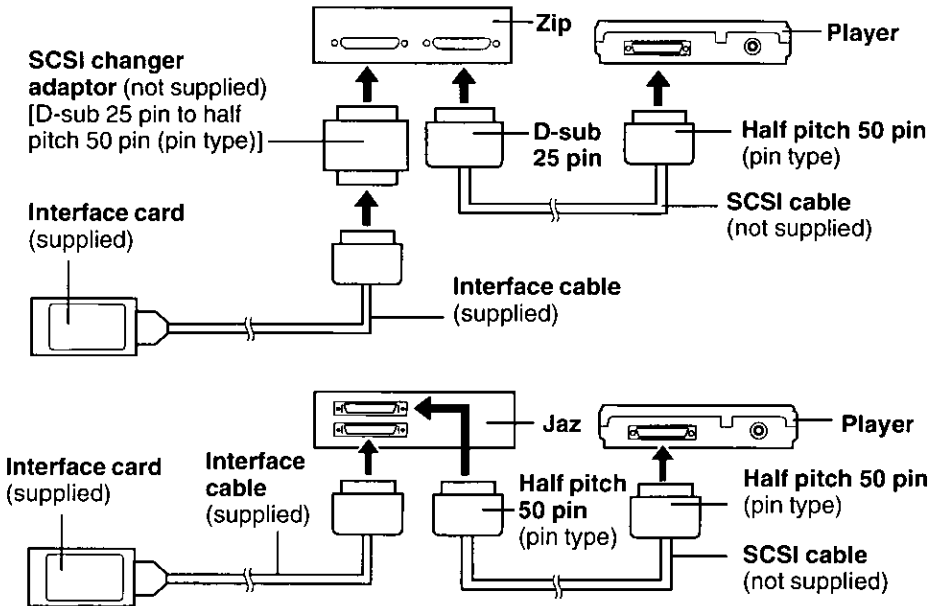

Notes:

- When connecting Zip or Jaz only to the computer;
 - set the terminator of Zip or Jaz to "ON".
- When connecting the computer, Zip or Jaz and player;
 - for proper data transfer, set the terminator of Zip or Jaz to "OFF" and of the player to "ON" (P. 36).
 - power from the computer (P. 29) cannot be supplied when connected with Zip or Jaz. Use the AC adaptor, alkaline battery or rechargeable battery.
 - the supplied interface card allow connecting only one unit of Zip or Jaz between the computer and the player.
 - do not use the same SCSI ID number for both the player and Zip or Jaz.

* Microsoft® Windows® 95 operating system (hereafter Windows 95).



Preparation

For desktop computer with SCSI board

Step 1 Connection

A commercial SCSI board and SCSI cable are required to connect the player to a desktop computer without PCMCIA card slot. For a recommended SCSI board, refer to "Option/Recommended Products" (P. 39). For further information, refer to your SCSI board manual.

First make sure both the player and the desktop computer are off.

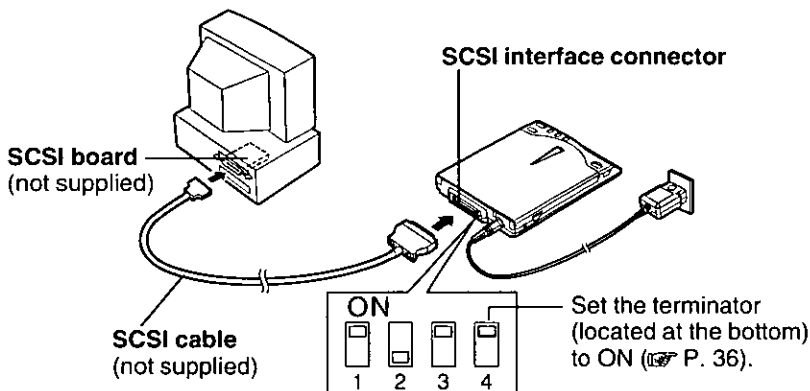

Cautions for a SCSI cable:

- Use a shielded SCSI cable of 1.5 m (4.9 ft.) or shorter.
- The connector connecting to the player should be half pitch 50 pin (pin type). Refer to your SCSI board manual for the type of the connector connecting to the computer side.

Step 2 Setting up your desktop computer

To use the player with your desktop computer, you must set up your computer. Please refer to the enclosed Setup Manual.

■ Daisy chain connection:

You can connect this player to other SCSI devices (up to seven devices). Make sure that each SCSI device has different SCSI ID number.



For the setting of SCSI ID number and terminator of this player, refer to "SCSI ID Number and Terminator Setting" (P. 36).

Since the player has only one SCSI connector, it must be the last device in the daisy chain. In this case, set the terminator of the player to ON (P. 36) and of the other SCSI devices to OFF.

Inserting / Removing a CD

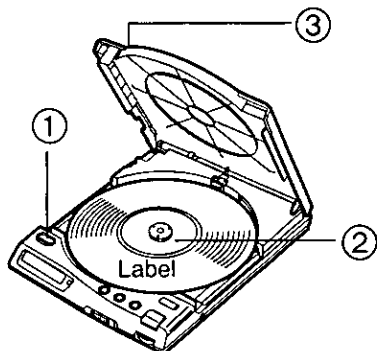
Inserting a CD



- ① Press  to open the disc cover and then raise it.
- ② Place a CD onto the disc spindle.
Press on the center of a CD until it locks onto the disc spindle.
- ③ Close the disc cover.
Press  on the disc cover.



Caution:

- Insert a CD firmly until it locks onto the spindle and then close the disc cover, or the CD may spin off the spindle and get damaged.

Removing a CD

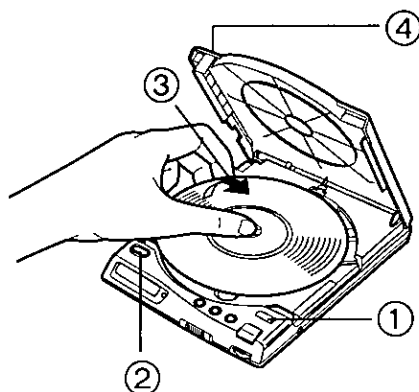
Make sure that the POWER/BUSY lamp (green) is not blinking.



- ① Press .
- ② After the CD stops spinning, press  to open the disc cover and then raise it.
- ③ Carefully remove the CD by lifting it.
Pressing on the disc spindle, lift the CD by holding its edge.
- ④ Close the disc cover.



Using the Player Independently

Playing an audio CD

You can listen to the music through your headphones/external speaker system (not supplied) connected to the PHONES jack.

The player is not specially designed to be used while walking, etc.

Be sure the VOLUME control is turned down (set to 2~4) before playing an audio CD.

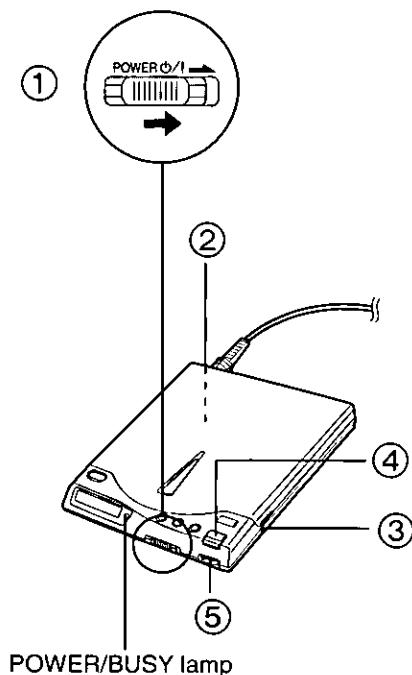

- ① To turn on the player, slide the **POWER** switch and hold it until the **POWER/BUSY** lamp lights.
■ To turn off the player, slide the power switch, then release it.
POWER/BUSY lamp goes off.

- ② Insert an audio CD (see P. 17).

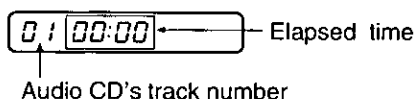









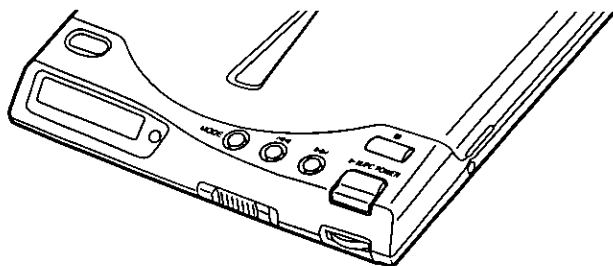

- ③ Plug your headphones or external speaker system (not supplies) into the **PHONES** jack.
- ④ Press  .
- ⑤ Rotate the **VOLUME** control to adjust the volume.

Note:

- It is recommended that the terminator of the player is set to OFF when using with the alkaline batteries or rechargeable battery. Power consumption can be saved (see P. 36).

■ Buttons function and operation:







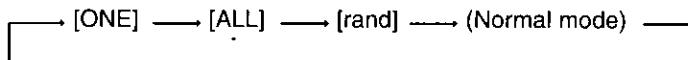

Function	Operation
Starts/pauses audio CD playback.	Press  .
Stops audio CD playback.	Press  .
Skips to the next track number.	Press  once.
Returns to the beginning of the track being played.	Press  once.
Skips to the previous track number.	Press  once when the elapsed time is 00:00.
Advances to your desired point.	Keep pressing  .
Reverses to your desired point.	Keep pressing  .
Repeats the track being played.*	Press  until "ONE" is displayed.
Repeats all tracks.*	Press  until "ALL" is displayed.
Repeats tracks at random.*	Press  until "rand" is displayed.

* Every time  is pressed, the mode changes in the following order.



Notes:

- To cancel the Repeat mode (*), press  . The mode is returned to Normal mode.
- When the blinking message "on" is displayed, the buttons  ,  ,  ,  and  cannot be used.
- If the alkaline batteries or rechargeable battery is used, the player will be automatically turned off after the last track is played when "Normal mode" is selected.



Using the Player with Computer

Make sure that all the necessary preparation is done (☞ P. 13~16, 36) and your computer has been set up properly (☞ Setup Manual).

■ Using with the supplied interface card:

Turning on the computer automatically turns on the player.

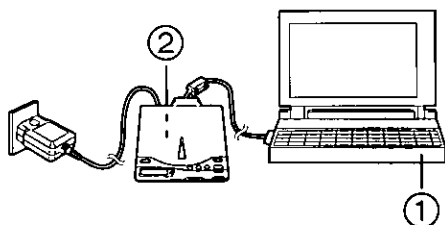

① Turn on the computer.

② Insert a CD (☞ P. 17).

■ Using with the SCSI board:

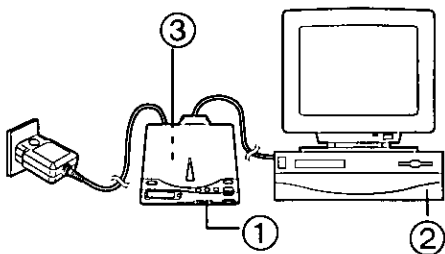

① Slide the power switch to turn on the player (☞ P. 18).

② Turn on the computer.

③ Insert a CD (☞ P. 17).

Notes:

- When POWER/BUSY lamp is blinking;
 - Do not open the disc cover.
 - Do not press .
 - Do not disconnect the interface card.
 - Do not turn off the player.
 - Do not remove the AC adaptor when it is used.
 - Do not remove the alkaline batteries or rechargeable battery when one of them is used.

Otherwise, your computer may hang up. If this happened, reset your computer.

- If  is displayed on the player's display when using the player with the alkaline batteries, rechargeable battery or power from the computer, quickly connect the AC adaptor. Otherwise your computer may hang up.
- If the interface card is used to connect the player and your computer under Windows 95, the computer cannot recognize the player when the player is turned off. To use the player again, reset the computer, or refresh the device manager after turning on the player. Refer to the "Help" file for detailed information (☞ P. 7 in Setup Manual).
- When using the alkaline batteries, rechargeable battery or power from the computer, you may notice the data transfer speed slows and access time increases.

Playing a CD-ROM

To use a CD-ROM, refer to the manual or "README" file included with the CD-ROM.

Note:

- Some types of CD-ROMs [game CD-ROM with audio track, CD-Extra, Portfolio CD (Photo CD), etc.] allow you to listen to the sound or music coming from the CD-ROM through the headphones/external speaker system (not supplied) connected to the PHONES jack of the player.

Connect the headphones/external speaker system (not supplied) with the PHONES jack of the player. If the LINE IN jack is equipped with the sound system of your computer, connect between the line in jack of the computer and PHONES jack of the player using a commercial audio cable.

Playing an audio CD

You can operate an audio CD on a computer using an audio CD control software (not supplied). Sound can be heard through the PHONES jack instead of from the computer.

Note:

- To listen to the sound or music from an audio CD, connect the headphones/external speaker system (not supplied) with the PHONES jack of the player. If the LINE IN jack is equipped with the sound system of your computer, connect between the line in jack of the computer and PHONES jack of the player using a commercial audio cable.



Using the Player with Computer

■ Running the software under Windows 95 or Windows NT® * 4.0:

You can use either of the following methods **A** or **B**.

- A** Select “**Multimedia**” from the Accessories group of Program Menu to start “**CD Player**”.

(Example)

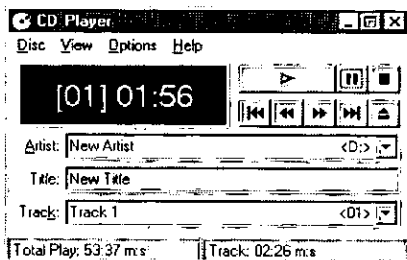



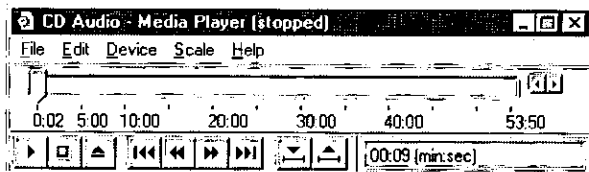

- B** 1. Select “**Multimedia**” from the Accessories group of Program Menu to start “**Media Player**”.
2. Select “**CD Audio**” from the Device menu.

(Example)



- If an audio CD control software is not installed, install the software using “Add/Remove Programs” in Control Panel. For detailed information, refer to the manual of Windows 95/Windows NT 4.0. In the case of Windows 95, also refer to “Help” file (P. 7 in Setup Manual). In the case of Windows NT 4.0, also refer to “README.TXT” file (P. 16 in Setup Manual).

Note:

- , ,  and  cannot be used when playing an audio CD with your computer.





* Microsoft® Windows NT® Workstation operating system and Microsoft® Windows NT® Server network operating system (hereafter Windows NT).

■ Running the software under Windows® 3.1, 3.11* / Windows NT 3.51:

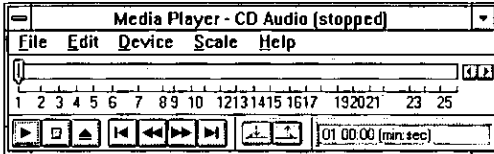
1. Start "Media Player" from the Accessories program group.
2. Select "CD Audio" from Device menu.

(Example)



- If the "CD Audio" is not displayed, install the Windows device driver "[MCI] CD Audio" from the Drivers in Control Panel. For detailed information, refer to the manual of Windows 3.1, 3.11/Windows NT 3.51 or "README.TXT" file (☞ P. 10, 13 in Setup Manual).
- When you are playing an audio CD with your computer, you cannot use , , , and . However, you can use these buttons by opening and closing the disc cover after exiting the audio CD control software. (☞ P. 19 for buttons function and operation.)

* Microsoft® Windows® operating system Version 3.1 or 3.11 (hereafter Windows 3.1, 3.11).



Insertion / Removal of the interface card

■ For Windows 95 user:

The supplied interface card supports the Hot Swapping (Plug & Play) function. With the computer turned on, you can insert/remove the interface card without fear of hardware damage. Before removing the interface card, perform the following steps.

- 1 Click PC Card icon  in task bar.



- 2 Click "Stop Panasonic KXLC004".



- 3 Make sure that the message "You may safely remove this device" is displayed, then click **OK**.

- 4 Remove the interface card.

■ For DOS / Windows 3.1, 3.11

With the computer turned on, you can insert/remove the interface card, if a PC Card Manager is installed on the computer (refer to your computer manual for details). However, do not remove the interface card when the POWER/BUSY lamp is lit or you start running your computer.

When you start running your computer, make sure that the interface card is inserted into the PCMCIA card slot.

Note:

- If your computer has more than one slot, and if you want to re-insert the interface card, you must insert it into the same slot it was inserted before.

■ For Windows NT user:

With the computer turned on, you cannot insert/remove the interface card. Please turn off your computer to insert/remove the interface card.

Using Alkaline Batteries (not supplied)

Six (6) "AA" size alkaline batteries are required.

Note:

- If the supplied interface card is used to connect between the player and your computer, power source is automatically changed from the batteries to the computer when the batteries run down (☞ P. 29).

■ Installing the batteries into the battery case:

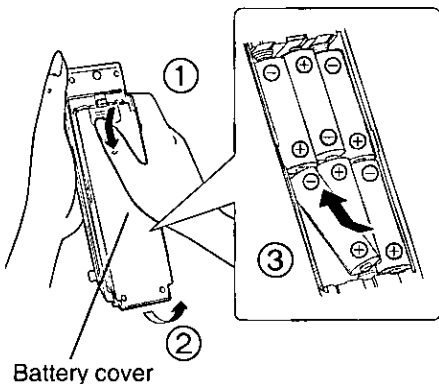

① Slide the battery cover to the arrow direction while pressing the battery cover.

② Open the battery cover.

③ Install six (6) "AA" size alkaline batteries (not supplied). Make sure the polarities (+, -) match the diagram.

④ Close the battery cover.

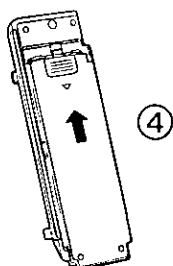

Using Alkaline Batteries (not supplied)

■ Installing the battery case:

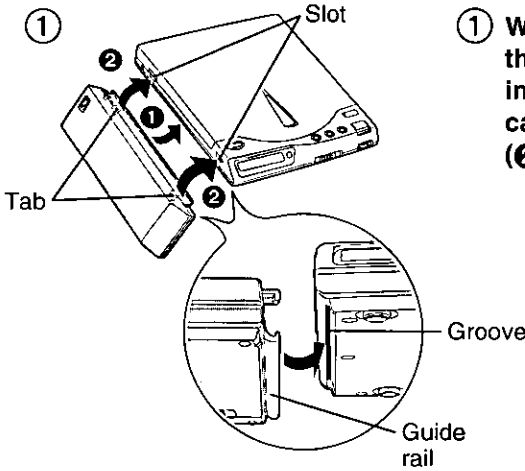

- ① While inserting the guide rail to the groove of the player (①), insert two (2) tabs of the battery case into the slots of the player (②).

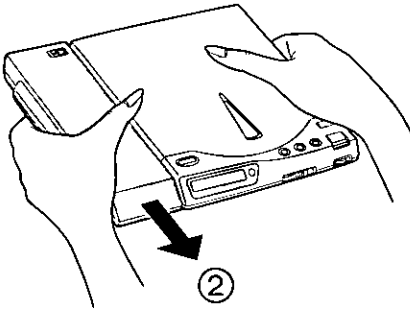

- ② Slide the battery case to the arrow direction until it clicks.

■ Replacing the Batteries:

Replace the batteries when blinking mark “” appears on the player's display. To remove the battery case from the player, while moving the release lever to the arrow direction (①), slide the battery case to the back side (②).

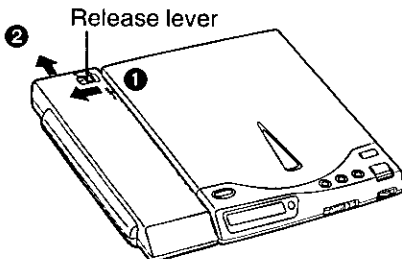

After removing the battery case, remove the batteries from the battery case, then install the new batteries ( P. 25).

Using Rechargeable Battery (option)

Use only the optional rechargeable battery (☞ P. 39).

Please read "Precautions" of the operating instructions supplied with the rechargeable battery.

Notes:

- Please do not leave the rechargeable battery without charging it for extended periods, or the life of the battery may shorten. Charge the battery once every 6 months even if you do not use it.
- Please remove the rechargeable battery and store in a cool place [less than 30°C {86°F}] when the player is not in use for extended periods (for more than 1 month) to extend its life.
- If the supplied interface card is used to connect between the player and your computer, power source is automatically changed from the rechargeable battery to the computer when the rechargeable battery runs down (☞ P. 29).
- Replace the rechargeable battery if it quickly runs down with use under normal temperature [about twice as fast as normal under 20°C {68°F}]. (It has reached the end of its life.)

Installing / Removing the rechargeable battery

Instructions are the same as the battery case of the alkaline batteries (☞ P. 26).



Charging rechargeable battery

Charge the rechargeable battery:

- before initial use.
- when the blinking mark "⏻" appears on the player's display.

Caution:

- Do not attempt to charge the rechargeable battery using a charger other than this player.

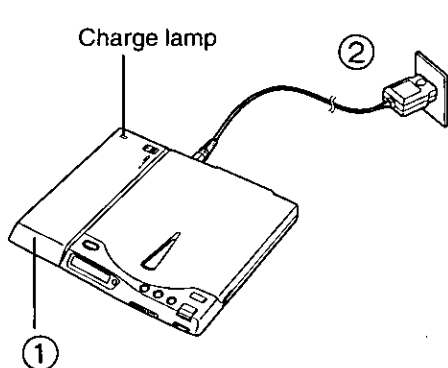

① Install the rechargeable battery.

Instructions are the same as the battery case of the alkaline batteries (☞ P. 26).

② Connect the supplied AC adaptor (☞ P. 13).

(Do not turn on the player.)

The charge lamp (red) lights when charging starts.

Charging will automatically finish when the charge lamp goes off.

A full battery charge requires a maximum of three (3) hours.

Notes:



- The rechargeable battery becomes warm while charging. This is not abnormal (☞ P. 33).
- The charging time may change depending on the level of remaining charge of the rechargeable battery.
- The rechargeable battery can be charged even when you are using the player (when the player is turned on). In this case, charging time becomes longer (maximum 30 hours).
- The rechargeable battery can be charged approximately 500 times. However, it changes depending on how it is used.

Using the Power from a Computer (through the Interface Card)

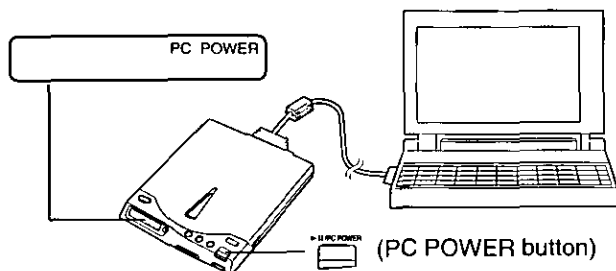
If the supplied interface card/cable is used between the computer and player, you can operate the player using the power from the computer (you do not need to connect the AC adaptor or install the alkaline batteries/rechargeable battery). The power from the computer is automatically supplied when the computer is turned on, then "PC POWER" is displayed on the player's display.



Notes:

- The power switch cannot be used when the power from the computer is used. To turn off the player, press  for more than 3 seconds.
- Set the terminator to OFF ( P. 36), or Power from computer can not be used.
- Depending on the performance of computer's power supply, the computer may not be able to supply power to the player. If the power of the computer or player is turned off or fails, or the other PC card is connected to the computer as well as the supplied interface card, use the AC adaptor with the player.
- When blinking mark " " is displayed, immediately connect the AC adaptor or use the alkaline batteries or rechargeable battery, otherwise the computer may hang up.
- For the computer, it is recommended to use the AC power instead of its battery (the battery of the computer goes low faster when the player uses the power from the computer).
- If the power from the computer is used, approximately 0.5 W of power is consumed even when the player is OFF.
Depending on the computer, power is supplied from it to the player even if the computer is in the power save mode.
If the player is not going to be used, it is recommended to remove the interface card.
- Power from the computer cannot be used when the player is connected with the SCSI board.
- It may take some time until the player can be used ("on" blinks).
- When you connect the player, Zip or Jaz and your computer with PCMCIA card slot, power from the computer is not sufficient for the player. Use the AC adaptor, alkaline batteries or optional rechargeable battery.



Using the Power from a Computer (through the Interface Card)

■ Using the power from computer with the other power sources installed:

You can force the player to use the power from the computer even with the other power sources (AC adaptor, alkaline batteries or rechargeable battery) installed. Using this function, you can stop power consumption of the alkaline batteries or rechargeable batteries without removing them from the player.

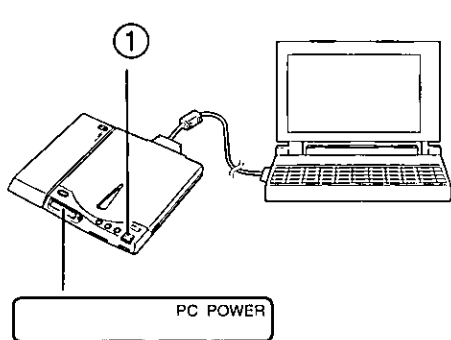



- ① Press “ (PC POWER)” button for more than 3 seconds. “PC POWER” is displayed when the power from the computer is selected.

To return to use the other power sources (AC adaptor, alkaline batteries or rechargeable battery) press “PC POWER” button again for more than 3 seconds.

“PC POWER” will disappear. If no other power sources are installed, the player is turned off.

Notes:

- You cannot switch from the other power sources to power from the computer even if  is pressed when the POWER/BUSY lamp is blinking.
- Once you switch to the power from the computer, the power does not automatically return to the AC adaptor, alkaline batteries or rechargeable battery even if they are installed afterwards.
- “E r r OP” (Error Operation) may appear when you press “ PC POWER”. In this case, remove and re-install the interface card for use under Windows 95 or reset the computer for use under other operating systems.

Troubleshooting

If trouble occurs, check the following points before returning the player for service.

Trouble	Possible Cause	Solution
Your computer does not recognize the player, or does not function properly.	The AC adaptor is not plugged into the outlet or DC IN jack correctly.	Plug the AC adaptor correctly (☞ P. 13).
	The Auto Protect function of AC adaptor is working.	Disconnect the AC adaptor and connect it again after 2~3 minutes.
	The alkaline batteries/battery case or rechargeable battery are/is not installed correctly, or dead.	Install the alkaline batteries/rechargeable battery properly, charge the rechargeable battery or replace with new batteries (☞ P. 25~28).
	■ For notebook/desktop computer with PCMCIA card slot user:	
	The computer has not been set up yet.	Set up the computer (☞ P. 14).
	The interface cable or card is not connected to the player or to the computer properly.	Properly connect the interface cable or interface card (☞ P. 14).
	The interface cable pin is bent or broken.	Consult your dealer (or contact Panasonic Service Center at 1-800-PANA-SYS for users in continental United States).
	When using under Windows 95, the player is turned off.	Reset the computer or refresh the device manager (☞ P. 20). Refer to the "Help" file for detailed information (☞ P. 7 in Setup Manual).
	When the power from the computer is used, the player's terminator is set to ON.	Set the terminator to OFF (☞ P. 36).
	When the power from the computer is used, the computer's battery is low.	It is recommended to use the AC power for the computer (☞ P. 12, 29).
When the power from the computer is used, power supply capacity of the computer is not sufficient.	Use the AC adaptor, alkaline batteries or rechargeable battery (☞ P. 12, 13, 25~28).	

(Continued)







Using the Power from a Computer
(through the Interface Card)



Troubleshooting









Troubleshooting

Trouble	Possible Cause	Solution	
Your computer does not recognize the player, or does not function properly.	When Zip or Jaz is connected, other software than Windows 95 is used.	Use Windows 95 (☞ P. 15).	
	When Zip or Jaz is connected, neither of the AC adaptor, alkaline batteries nor rechargeable battery is connected (power from the computer cannot be used when Zip or Jaz is connected).	Use the AC adaptor, alkaline batteries or rechargeable battery (☞ P. 13, 15, 25~28).	
	When Zip or Jaz is connected, the player's terminator is set to OFF.	Set the terminator to ON (☞ P. 36).	
	When Zip or Jaz is connected, the same SCSI ID number is used for Zip/Jaz and the player.	Change the SCSI ID number (☞ P. 36) or refer to the manual of Zip or Jaz.	
	■ For desktop computer with SCSI board user:		
	Neither of the AC adaptor, alkaline batteries nor rechargeable battery is connected (power from the computer cannot be used when the SCSI board is used).	Use the AC adaptor, alkaline batteries or rechargeable battery (☞ P. 13, 25~28).	
	The computer has not been set up yet.	Set up the computer (☞ P. 16).	
	The computer was turned on before the player was turned on.	Turn off the player and computer, and turn on the player first then turn on the computer (☞ P. 20).	
Transmission speed of data slows down.	The SCSI cable is not connected to the board.	Properly connect the SCSI cable (☞ P. 16).	
	The same SCSI ID number(s) is/are used for the player/SCSI device(s) with the daisy chain connection.	Use the different SCSI ID number(s) for the player and each SCSI device(s) (☞ P. 16, 36).	
	The player's terminator is set to OFF.	Set the terminator to ON (☞ P. 16, 36).	
	Using the player with the alkaline batteries/rechargeable battery or the power from the computer.	Use the AC adaptor.	

Trouble	Possible Cause	Solution
Transmission speed of data slows down.	A warped CD is used, then the vibration detection sensor (G sensor) is activated slowing down rotation of CD.	To disable the sensor, press MODE  when "on" is displayed. The following message is displayed (G OFF):  Press MODE  again to reactivate the sensor (☞ P. 37).
	The notebook computer has entered the power management mode.	Set the CPU speed of the notebook computer faster in power management or use the AC adaptor for the computer.
The player (especially disc spindle), battery case, rechargeable battery, AC adaptor or interface card is warm.		This is not abnormal. If they become hot, consult your dealer.
The optional rechargeable battery cannot be charged (charge lamp does not light).	AC adaptor is not connected or the rechargeable battery is not installed properly.	Connect the AC adaptor or install the rechargeable battery properly (☞ P. 13, 27).
The optional rechargeable battery runs down too soon.	The rechargeable battery was not charged properly or has reached the end of its life.	Charge the rechargeable battery until the charge lamp goes off or replace it (☞ P. 28).
"no DISC" message appears on player's display even after inserting a CD. Sound skips, or data can not be read.	CD is placed with the label side facing down.	Place the CD with the label side facing up (☞ P. 17).
	CD without  or  mark is used.	Use the CD marked with  or  (☞ P. 4).
	CD or the lens of the player may have become dirty.	Clean the CD or the lens of the player (☞ P. 35).
	CD is damaged.	Replace with another CD.
	Dust such as a hair lay on the disc spindle.	Clean the disc spindle.



Troubleshooting

Trouble	Possible Cause	Solution
"no DISC" message appears on player's display even after inserting a CD. Sound skips, or data can not be read.	The player or/and CD are damp or moist, because the player or/and CD may have been moved from a cold place to a warm place.	Remove the CD from the player and do not use the player and CD for about 1 hour.
You can not listen to sound coming from the PHONES jack of the player.	Headphones are not connected.	Connect the headphones to the PHONES jack firmly (☞ P. 11, 18, 21).
	The player's VOLUME control is set to "0".	Set the player's VOLUME control to a higher level (☞ P. 11, 18).
	■ When the computer's sound system and the player's PHONES jack is connected: the volume is set to the lowest level in the "Volume Control" or "Mute" is selected on the software control of the sound device.	Set the volume higher level, or cancel the "Mute" selection. For further information refer to your sound device manual.
CD does not stop rotating, though  is pressed.	Data is being sent from the computer (POWER/BUSY lamp is blinking).	Exit the software you are using with the player, then wait until the POWER/BUSY lamp stops blinking.
An audio CD is inserted and the power is on, but buttons on the player do not function.	When the player is connected to the computer,  ,  ,  or  is pressed.	When the player is connected to the computer, these player's buttons do not function (☞ P. 12).
	System lockup.	Press RESET switch (☞ P. 11).
The player cannot be turned off.	Tried to turn off the player by using the power switch when the player is used with the power from the computer.	When the power from the computer is used, the power switch does not operate to turn off the player (☞ P. 29).
	System lockup.	Press RESET switch (☞ P. 11).
 is pressed, but the power is not switched to the power from the computer.	 is pressed when POWER/BUSY lamp is blinking or player's terminator is set to ON.	Press  when POWER/BUSY lamp is not blinking or set the player's terminator to OFF.

Maintenance

■ Player:

Cautions:

- Do not use benzine, thinner, etc.
- Do not use commercial lens cleaner.

Clean the terminals with dry cotton swab or dry cloth about once a month.

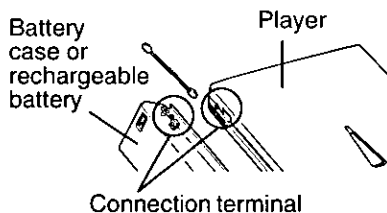

Clean the outside of the player with a soft, dry cloth.

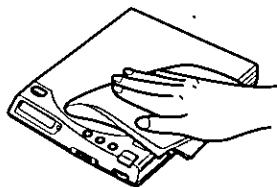

Clean the lens with a commercial lens blower.

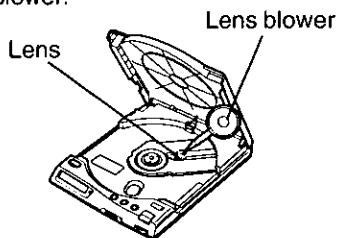

■ CD:

Cautions:

- Do not use solvents such as benzine, record cleaners or anti-static spray for records.
- Do not touch the signal side.

Wipe from the center to the edge with a dry, soft cloth.



SCSI ID Number and Terminator Setting

■ SCSI ID number:

Each SCSI device connected to your computer can be assigned an individual ID number (refer to the respective manuals). Be sure that the player's SCSI ID number is not same as another SCSI device connected to the computer.

The factory setting of the player's SCSI ID number is set to 5.

■ Terminator:

The factory setting is **OFF**.

- ON:**
- When the supplied interface card is used to connect to Zip or Jaz drive.
 - When the desktop computer is connected with a SCSI board (not supplied) (☞ P. 16). If SCSI devices are connected, set their terminators to OFF.
- OFF:**
- When the supplied interface card is used to connect to a computer (☞ P. 14). (power from the computer can be used).
 - When using independently as an audio CD player (☞ P. 18) with the alkaline batteries or rechargeable battery installed (power consumption can be saved).

Setting

Make sure that the player is off.

Set the SCSI ID number switch (1~3) or Terminator switch (4) ON/OFF by using a pointed object like a pen (do not use a pencil), and referring to the table below (for SCSI ID number).

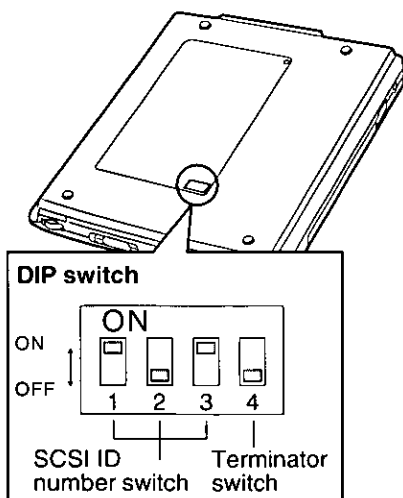

Example: SCSI ID number=5
Terminator=OFF

(For SCSI ID number setting)

SCSI ID number	SCSI ID number switch		
	1	2	3
0	OFF	OFF	OFF
1	ON	OFF	OFF
2	OFF	ON	OFF
3	ON	ON	OFF
4	OFF	OFF	ON
5	ON	OFF	ON
6	OFF	ON	ON
7*	ON	ON	ON

: **Factory setting**

* Do not use "7" for player's SCSI ID number, since it is used for the interface card or SCSI board.

Specifications

Operating Environment (under no damp or moist conditions):	Temperature: 5°C {41°F} to 35°C {95°F} Humidity: 20% to 85% RH				
Storage Environment (Non-condensing):	Temperature: -20°C {-4°F} to 55°C {131°F} Humidity: 15% to 85% RH				
Dimensions:	130 (W)×162.8 (D)×24.3 (H) mm {5.12"×6.41"×0.96"}				
Mass {Weight}:	Approx. 345 g {0.76 lbs.} (without battery case)				
Power Source:	<ul style="list-style-type: none"> • AC Adaptor: 100 — 240V, 50/60 Hz • Six (6) "AA" size alkaline batteries: Battery case is supplied but batteries are not included • Power from computer: Uses power from PCMCIA card slot • Rechargeable battery (Ni-Cd): Optional KXL-D32 				
Interface:	SCSI-2 (Player), PCMCIA 2.1 (interface card)				
SCSI Connector:	Half-pitch 50-pin				
Buffer Size:	128 KB				
MPC:	MPC level 2, level 3*1 (The capability differs depending on the computer or software.)				
Battery Life *2 [at 20°C {68°F}]:	<ul style="list-style-type: none"> • When using Panasonic "AA" size alkaline batteries or optional rechargeable battery continuously <table border="1" style="margin-left: auto; margin-right: auto;"> <tr> <td>Audio CD</td> <td>Approx. 3.5 h</td> </tr> <tr> <td>CD-ROM</td> <td>Approx. 3 h</td> </tr> </table>	Audio CD	Approx. 3.5 h	CD-ROM	Approx. 3 h
Audio CD	Approx. 3.5 h				
CD-ROM	Approx. 3 h				
Data Transfer Rate *3 (when using AC adaptor*4):	<ul style="list-style-type: none"> • When connected to desktop computer with SCSI board 1350 KB/s (inner: 9X) — 3000KB/s (outer: 20X) • When using the interface card 1350 KB/s (inner: 9X) — 2700KB/s (outer: 18X) 				

*1 When desktop computer is connected and using Windows 3.1, 3.11.

*2 When using the player with the terminator ON, this may become shorter.

*3 The rate may become lower depending on the computer.

Also, if a warped CD, etc. is used, the rate becomes lower automatically to minimize vibration while the CD is rotating (☞ P. 33).

*4 To conserve power, inner speed becomes 2.6X and outer speed becomes 6X when using with the alkaline batteries, rechargeable battery or power from the computer.



Specifications

Access Time*¹ (The information is based on the test results measured by Panasonic test software):	<ul style="list-style-type: none"> When using AC adaptor 1/3 stroke: 130 ms typical 	
Power Consumption:	<ul style="list-style-type: none"> When using with AC adaptor Approx. 10 W when playing CD-ROM Approx. 1 W when the player is turned off. When using with the power from computer (DC 5 V) Max 4.4 W when playing CD-ROM Approx. 0.5 W when the player is turned off. 	
Compatible CD, CD-ROM Format:	CD-DA (Audio CD) CD-ROM (Mode 1 and Mode 2 Form 1) CD-ROM XA (Mode 2 Form 2) CD-i* ² VIDEO CD* ² CD Extra Photo CD* ³ (Multisession)	
Error Rates:	Soft read errors Hard read errors	Less than 10 ⁻⁹ Less than 10 ⁻¹²
Audio Performance Phones out (stereo):	S/N Maximum output level	More than 80 dB (A Range) 14 mW (EIAJ) (impedance 16 Ω)
Interface Card and Interface Cable:	Power source Card type Card dimensions SCSI connector Cable length Data transfer rate Mass {Weight} (with cable)	DC 5 V, Approx. 100 mA PCMCIA Type II 54 (W)×85.6 (D)×5 (H) mm {2.13"×3.37"×0.20"} Half-pitch 50-pin (pin type) Approx. 350 mm (without connector) 7 MB/s (MAX.) Approx. 130 g {0.287 lbs.}
Interface Card Corresponded Device:	Zip* ⁴ * ⁵ and Jaz drive (SCSI model)* ⁵	

*¹ When using the alkaline batteries, optional rechargeable battery or power from the computer, the access time increases.

*² To playback CD-i or VIDEO CD, software or hardware MPEG decoding capability is required in the computer.

*³ To playback Photo CD, a commercial playback software is required.

*⁴ SCSI changer adaptor [D-sub 25 pin – half pitch 50 pin (pin type)] is required.

*⁵ A commercial SCSI cable is required to connect the computer, Zip or Jaz and the player (P. 15).

Option / Recommended Products

Option

The following option is available through your local Panasonic authorized parts distributor.

Model No.	Model Name
KXL-D32	Rechargeable Battery (Ni-Cd)

Recommended Products (for Windows 95, DOS / Windows 3.1, 3.11)

■ To use CD-i or VIDEO CD:

Common name	Product name (Maker)
MPEG PLAY VIDEO Card	REAL Magic Pro (Sigma Designs, Inc.)

■ To connect the player to a desktop computer without PCMCIA card slot:

Common name	Product name (Maker)
SCSI board	AHA-1542, AHA-2940 (Adaptec, Inc.)



End-User License Agreement

THIS IS A LEGAL AGREEMENT BETWEEN YOU AND PANASONIC. CAREFULLY READ ALL THE TERMS AND CONDITIONS OF THIS AGREEMENT PRIOR TO OPENING THE PACKET OF SOFTWARE PROGRAM. OPENING THE PACKET INDICATES YOUR ACCEPTANCE OF THESE TERMS AND CONDITIONS. If you do not agree to these terms and conditions, return the unopened packet and the other components of the Panasonic product to the place of purchase and your money will be refunded. No refunds will be given for product that have an opened packet or missing components.

1. COPYRIGHT:

Panasonic has the right to license or has been granted to license the enclosed software program ("SOFTWARE"), developed and copyrighted by Kyushu Matsushita Electric Co., Ltd. or its licensor ("Licensor"). You acknowledge that you are receiving only a LIMITED LICENSE TO USE the SOFTWARE and related documentation, and that you shall obtain no title, ownership nor any other rights in or to the SOFTWARE and related documentation, all of which title and rights shall remain with Licensor and Panasonic.

2. LICENSE:

(1) You have the non-exclusive right to use the one copy of the SOFTWARE on a single computer used by single user. Installation of the SOFTWARE on a network server for the purpose of distribution to one or more other computers shall not be granted in this Agreement. (2) You may not copy, reproduce, or permit to be copied or reproduced, the SOFTWARE or related documentation for any purpose, except that you may either (a) make a reasonable quantity of copies of the SOFTWARE solely for backup or archival purposes, or (b) transfer the SOFTWARE to a single hard disk, provided that you keep the original solely for backup or archival purposes. All other copies of the SOFTWARE are in violation of this Agreement. (3) You may not rent or lease the SOFTWARE, but you may transfer your right under this License Agreement on a permanent basis, provided that you transfer this Agreement, all copies of the SOFTWARE, all related documentation and your Panasonic product, and the recipient thereof agrees the terms of this Agreement. (4) You may not reverse engineer, decompile or disassemble the SOFTWARE, except that in European Union and European Free Trade Association, you may have the limited right to reverse engineer, decompile or disassemble the SOFTWARE solely to the extent specifically permitted by the terms and conditions of Article 6 of the European Community's Directive for the Legal Protection of Computer Programs, OJL 122/42 (17 May 1991). (5) You may not use, copy, modify, alter, or transfer the SOFTWARE, or any copy thereof, in whole or in part, except as expressly provided in this Agreement.

3. TERM:

This license is effective until terminated. You may terminate this Agreement at any time by destroying the SOFTWARE and related documentation and all copies thereof. This license will also terminate if you fail to comply with any term or condition of this Agreement. Upon such termination, you agree to destroy all copies of the SOFTWARE and related documentation.

4. LIMITED WARRANTY

Within ninety (90) days of your receipt of the SOFTWARE, Panasonic warrants that the storage media on which the SOFTWARE are furnished is free from defect in materials and workmanship under normal use, and that it will repair or at its option replace any defective media at no charge to you, provided that such defective media is returned to Panasonic within such ninety (90) days period.

5. LIMITATION OF LIABILITY:

EXCEPT AS STATED ABOVE, NEITHER PANASONIC, PANASONIC'S SUPPLIER MAKES OR PASSES ON TO YOU OR OTHER THIRD PARTY, ANY WARRANTY OR REPRESENTATION INCLUDING, BUT NOT LIMITED TO, THE IMPLIED WARRANTY OF MERCHANTABILITY AND FITNESS FOR A PARTICULAR PURPOSE. WITHOUT LIMITING THE GENERALITY OF THE FOREGOING, NEITHER PANASONIC NOR PANASONIC'S SUPPLIER WARRANTS THAT THE SOFTWARE WILL BE ERROR-FREE OR THAT IT WILL MEET YOUR REQUIREMENTS. NEITHER PANASONIC NOR PANASONIC'S SUPPLIER SHALL BE LIABLE FOR ANY DAMAGE SUFFERED BY YOU INCLUDING, BUT NOT LIMITED TO, CONSEQUENTIAL, INCIDENTAL SPECIAL OR PUNITIVE DAMAGES. THE ABOVE LIMITATIONS SHALL APPLY REGARDLESS OF THE FORM OF ACTION WHETHER IN CONTRACT, TORT (INCLUDING NEGLIGENCE), STRICT PRODUCT LIABILITY OR OTHERWISE, EVEN IF SUCH PARTY HAS BEEN ADVISED OF THE POSSIBILITY OF SUCH DAMAGES.



Index

A

- AC adaptor 6, 8, 13
- Accessories 6
- Alkaline batteries 9, 25
- Audio CD control software 22, 23
 - For Windows 3.1, 3.11/
Windows NT 3.51 23
 - For Windows 95/
Windows NT 4.0 22

B

- Battery 25
 - Alkaline "AA" size 9, 25, 26
 - Rechargeable (Ni-Cd) 9, 27, 28
- Battery case 25, 26
- Buttons for playing audio CD 19

C

- CD-ROM 4, 12, 21
- Charging rechargeable battery 28
- Connection 13~16
 - AC adaptor 13
 - Interface cable/card 14
 - SCSI cable/SCSI board 16
 - Zip/Jaz 15

D

- Daisy chain 16
- DC IN jack 11, 13
- Desktop computer 14, 16
- DIP switch 11, 36
- Disc cover 10, 17
- Display 10, 12
- Display Messages 12
- DOS 24

E

- End-User License Agreement 40

F

- Features 4
- Forward skip/search button 10, 19

I

- Inserting a CD 17
- Insertion/Removal of
 - interface card 24
- Interface cable 6, 14
- Interface card (PCMCIA) 6, 14

M

- Maintenance 35
- MODE button 10, 12, 19

N

- Notebook computer 14

O

- OPEN button 10, 17
- Option 27, 39

P

Part Names 10
 PC POWER 11, 12, 29, 30
 PCMCIA card slot 14, 24
 PHONES jack 11, 18, 21
 PLAY/PAUSE/PC POWER
 button 11, 19, 29, 30
 Playing audio CD 18, 21
 Playing CD-ROM 21
 POWER/BUSY lamp 10
 Power from computer 29, 30
 Power On 18, 20
 POWER switch 10
 Precautions 7
 Preparation 14

R

README file 22, 23
 Rechargeable battery 27
 Recommended Products 39
 Removing a CD 17
 Repeat 12, 19
 RESET switch 11, 34
 Reverse skip/search button ... 10, 19

S

SCSI ID number 11, 15, 16, 36
 SCSI interface connector ... 11, 14~16
 Setting SCSI ID number/
 Terminator 11, 15, 16, 36
 Setting up computer 14, 16
 Setup disk 6, 14
 Setup Manual 6, 14, 16
 Specifications 37
 STOP button 11, 17, 19, 20

T

Terminator 11, 16, 36
 Troubleshooting 31

U

Using player independently 18
 Using player with computer 20

V

VOLUME control 11, 18

W

Windows 3.1, 3.11 23, 24
 Windows 95 22, 24
 Windows NT 3.51 23, 24
 Windows NT 4.0 22, 24

Z

Zip/Jaz 15, 32



FOR USERS IN CONTINENTAL UNITED STATES ONLY

Technical Support Calls

If you have read this manual and Setup Manual and tried the troubleshooting procedures, and you are still having difficulty, please contact the store from which the unit was purchased. Panasonic Communications & Systems Company will repair this product with new or refurbished parts free of charge for two (2) years from the date of purchase.

You may also call the technical support telephone number (24 hour, 7 day/week automated technical support. Live technical support M-F, 9 am – 5 pm EST).

**The technical support number is: 1-800-PANA-SYS
(1-800-726-2797)**

Software drivers are sometimes updated. You can download the latest driver or new setup disk via your modem.

Internet: www.PANASONIC.com

BBS: @ 201-863-7845

This product is designed for use only in the country where it was purchased.

Panasonic Computer Peripheral Company
Division of Panasonic Communications & Systems Company
A Unit of Matsushita Electric Corporation of America
Two Panasonic Way, Secaucus, New Jersey 07094

Panasonic Sales Company
Division of Matsushita Electric of Puerto Rico, Inc.
San Gabriel Industrial Park, 65th Infantry Avenue KM. 9.5
Carolina, Puerto Rico 00630

Panasonic Canada Inc.
5770 Ambler Drive, Mississauga, Ontario, L4W 2T3

Matsushita Electric Industrial Co., Ltd.
Central P.O. Box 288, Osaka 530-91, Japan
